

- Space saving: compact
- Tinned copper block: high conductivity
- IP 20 protection/UL finger-safe: improved safety
- Cable fixing screw diameters >95% fill ratio: excellent electrical contact,
- safe connections
- Visual inspection of wire: confirmation of connection
- Hinged or removable cover: easy wiring
- Clip-on DIN rail or mount to panel with screws: easy fixing

### Attachment



LK 80 A



LK-80A CE RoHS

80A IEC 60947-7-1

85 Amp (UL certification application)

Modular: keeping only one input, the blocks can be connected in parallel using a jumper wire. Easily double or triple the neutral.

Metric system	mm <sup>2</sup>			I(N.m)
	6...16	x1		3.5
	2.5...6	x4		1.2
	2.5...16	x2		3.5

U.S. Regulations	AWG			Torque
	16...4	x1		19.5
	16...8	x4		10.6
	16...4	x2		19.5

- I=80 A IEC
- I=85 A UL/CSA
- Icw KA rms Is: 3
- IPk KA: 22
- U: 690V IEC
- Vin: 600 V UL



Installation Hole: 54mm

LK 125 A



LK-125A CE RoHS

125A IEC 60947-7-1

150 Amp (UL certification application)

Modular: keeping only one input, the blocks can be connected in parallel using a jumper wire. Easily double or triple the neutral.

Metric system	mm <sup>2</sup>			I(N.m)
	10...35	x1		8.5
	6...16**	x1		3.5
	2,5...16	x6  x4		3.5

\*\* or common jumper

U.S. Regulations	AWG			Torque
	8...1/0	x1		57
	14...4	x1		31
	14...4	x6		31

- I=125 A IEC
- I=150 A UL/CSA
- Icw KA rms Is: 4.2
- IPk KA: 30
- U: 690V IEC
- Vin: 600 V UL

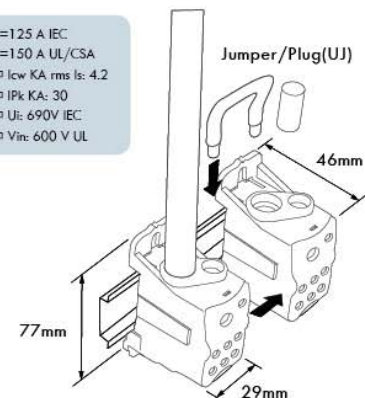

Installation Hole: 64mm

LK 160 A



LK-160A CE RoHS

160A IEC 60947-7-1

200 Amp (UL certification application)

Modular: keeping only one input, the blocks can be connected in parallel using a jumper wire. Easily double or triple the neutral.

Metric system	mm <sup>2</sup>			I(N.m)
	10...70	x1		8.5
	6...16**	x1		3.5
	2,5...16	x6  x4		3.5

\*\* or common jumper

U.S. Regulations	AWG			Torque
	8...3/0	x1		75
	14...4	x1		31
	14...4	x6		31

- I=160 A IEC
- I=200 A UL/CSA
- Icw KA rms Is: 11.8
- IPk KA: 30
- U: 690V IEC
- Vin: 600 V UL

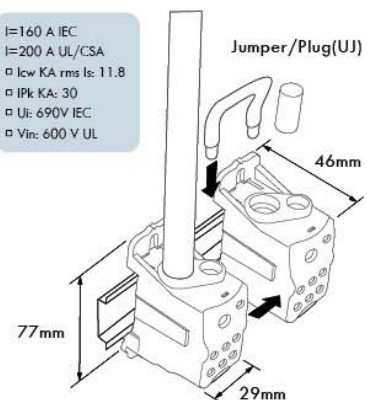

Installation Hole: 64mm

LK 250 A



**NEW**

**LK-250A** CE RoHS

**250A IEC 60947-7-1**  
**255 Amp** ( UL certification application )

Modular:allows versatile building of power blocks single pole, two pole,three pole or four pole.

Metric system	mm <sup>2</sup>	mm <sup>2</sup>		I(N.m)
	35...120		x1	19
	6...35	6...25	x2	4.4
	2.5...16	2.5...16	x5	2.7
	2.5...10	2.5...10	x4	2.7

U.S. Regulations	AWG		Torque
	6...250 Kcmil	x1	221
	14...1	x2	39
	14...4	x5	24
	14...6	x4	24

- I=250 A IEC
- I=255 A UL/CSA
- Icw KA rms Is: 24.5
- IPk KA: 51
- Ui: 690V IEC
- Virc: 600 V UL

Flexible with TF 250A busbar connection with the TH

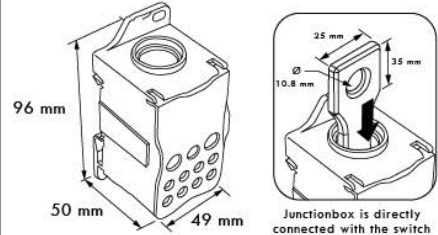

Installation Hole:85×29mm

LK 400 A



**NEW**

**LK-400A** CE RoHS Conform to

**400A IEC 60947-7-1**  
**335 Amp** ( UL certification application )

Modular:allows versatile building of power blocks single pole, two pole,three pole or four pole.

Metric system	mm <sup>2</sup>	mm <sup>2</sup>		I(N.m)
	95...185		x1	25
	6...35	6...25	x2	4.4
	2.5...16	2.5...16	x5	2.7
	2.5...10	2.5...10	x4	2.7

U.S. Regulations	AWG		Torque
	3/0...400 Kcmil	x1	221
	14...1	x2	39
	14...4	x5	24
	14...6	x4	24

- I=400 A IEC
- I=335 A UL/CSA
- Icw KA rms Is: 24.5
- IPk KA: 51
- Ui: 690V IEC
- Virc: 600 V UL

Flexible with TF 400A busbar connection with the TH

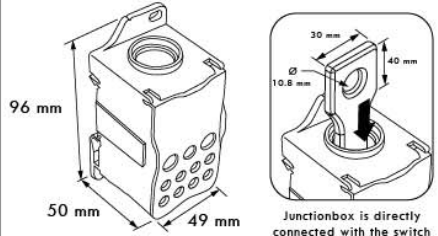

Installation Hole:85×29mm

LK 500 A



**NEW**

**LK-500A** CE RoHS

**500A IEC 60947-7-1**  
**520 Amp** ( UL certification application )

Modular:allows versatile building of power blocks single pole, two pole,three pole or four pole.

Metric system	mm <sup>2</sup>	mm <sup>2</sup>		I(N.m)
	4x15.5x0.8 ...8x24x1	4x15.5x0.8 ...8x24x1		10
	6...35	6...25	x2	4.4
	2.5...16	2.5...16	x5	2.7
	2.5...10	2.5...10	x4	2.7

U.S. Regulations	AWG		Torque
	4x15.5x0.8 ...8x24x1		88.5
	14...1	x2	39
	14...4	x5	24
	14...6	x4	24

- I=500 A IEC
- I=520 A UL/CSA
- Icw KA rms Is: 24.5
- IPk KA: 51
- Ui: 690V IEC
- Virc: 600 V UL

TH flexible busbar

	4 x 15.5 x 0.8
	6 x 15.5 x 0.8
	2 x 20 x 1
	3 x 20 x 1
	4 x 20 x 1
	5 x 20 x 1
	6 x 20 x 1
	2 x 24 x 1
	3 x 24 x 1
	4 x 24 x 1
	5 x 24 x 1
	6 x 24 x 1
	8 x 24 x 1

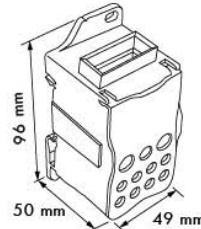

Installation Hole:85×29mm

# Distribution Terminal Blocks

UK 207

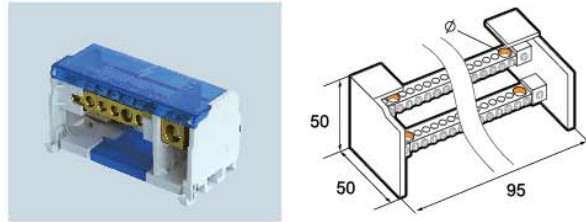

Type	Size	Terminals per pole
UK207	Solid core lead multistrand lead [mm*] L H W	2 pole
EN60947-1 CE Certificate	1.5-6mm <sup>2</sup> 6-16mm <sup>2</sup> 94x50 x44mm	1 x 16mm <sup>2</sup> 1 x 25mm <sup>2</sup> 5 x 6mm <sup>2</sup>
KA rating pead Max. Current 100A Voltage 500V	For  type	

UK 211

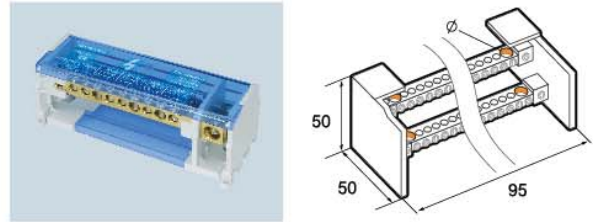

Type	Size	Terminals per pole
UK 211	Solid core lead multistrand lead [mm*] L H W	2 pole
EN60947-1 CE Certificate	1.5-6mm <sup>2</sup> 6-16mm <sup>2</sup> 10-16mm <sup>2</sup> 10-25mm <sup>2</sup> 10-35mm <sup>2</sup>	3 x 16mm <sup>2</sup> 1 x 25mm <sup>2</sup> 7 x 6mm <sup>2</sup>
KA rating pead Max. Current 125A Voltage 500V	For  type	

UK 215

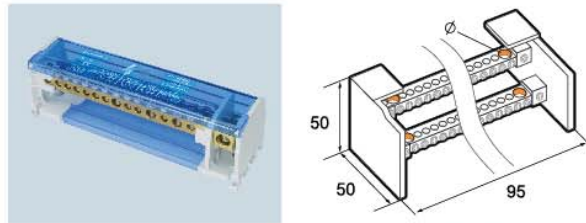

Type	Size	Terminals per pole
UK 215	Solid core lead multistrand lead [mm*] L H W	2 pole
EN60947-1 CE Certificate	1.5-6mm <sup>2</sup> 6-16mm <sup>2</sup> 10-25mm <sup>2</sup> 2.5-6mm <sup>2</sup> 10-35mm <sup>2</sup>	3 x 16mm <sup>2</sup> 1 x 25mm <sup>2</sup> 11 x 6mm <sup>2</sup>
KA rating pead Max. Current 125A Voltage 500V	For  type	

UK 407

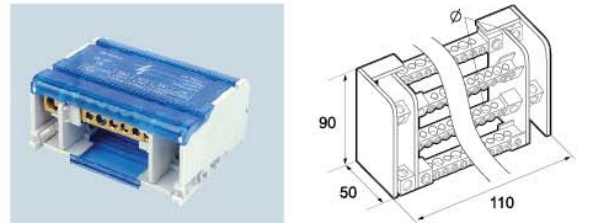

Type	Size	Terminals per pole
UK407	Solid core lead multistrand lead [mm*] L H W	4 pole
EN60947-1 CE Certificate	1.5-6mm <sup>2</sup> 6-16mm <sup>2</sup> 2.5-6mm <sup>2</sup> 10-25mm <sup>2</sup>	1 x 16mm <sup>2</sup> 1 x 25mm <sup>2</sup> 5 x 6mm <sup>2</sup>
KA rating pead Max. Current 125A Voltage 500V	For  type	

UK 411

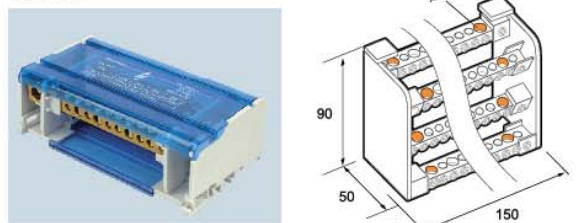

Type	Size	Terminals per pole
UK411	Solid core lead multistrand lead [mm*] L H W	4 pole
EN60947-1 CE Certificate	1.5-6mm <sup>2</sup> 6-16mm <sup>2</sup> 10-16mm <sup>2</sup> 10-25mm <sup>2</sup> 10-35mm <sup>2</sup>	3 x 16mm <sup>2</sup> 1 x 25mm <sup>2</sup> 7 x 6mm <sup>2</sup>
KA rating pead Max. Current 125A Voltage 500V	For  type	

UK 412

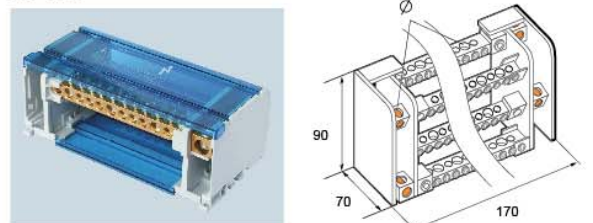

Type	Size	Terminals per pole
UK412	Solid core lead multistrand lead [mm*] L H W	4 pole
EN60947-1 CE Certificate	1.5-6mm <sup>2</sup> 6-16mm <sup>2</sup> 10-16mm <sup>2</sup> 2.5-6mm <sup>2</sup> 10-35mm <sup>2</sup>	3 x 16mm <sup>2</sup> 1 x 25mm <sup>2</sup> 7 x 6mm <sup>2</sup>
KA rating pead Max. Current 160A Voltage 500V	For  type	

UK 415

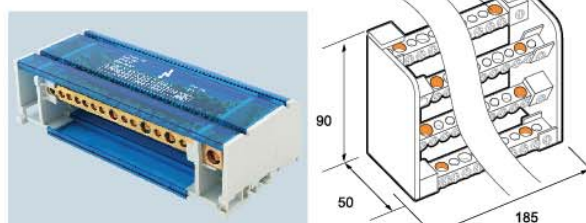

Type	Size	Terminals per pole
UK415	Solid core lead multistrand lead [mm*] L H W	4 pole
EN60947-1 CE Certificate	1.5-6mm <sup>2</sup> 6-16mm <sup>2</sup> 10-25mm <sup>2</sup> 2.5-6mm <sup>2</sup> 10-35mm <sup>2</sup>	3 x 16mm <sup>2</sup> 1 x 25mm <sup>2</sup> 11 x 6mm <sup>2</sup>
KA rating pead Max. Current 125A Voltage 500V	For  type	